

OUR 75th ANNIVERSARY  
1906 — 1981



The  
Traffic Club  
of  
New York, Inc.

1981  
71st ANNUAL DINNER



**You name it...  
We'll move it...**

By the carload, trainload, piggyback trailer or container. We'll move it quickly, efficiently and economically.

The Santa Fe/Conrail all-piggyback run-thru is just one example of how we're serving east coast shippers. This all-weather service, via Streator, Illinois, provides New England, New York City and northern New Jersey shippers with 5th morning west coast availability. Comparable service eastbound, too!

**CALL OUR TRANSPORTATION SPECIALISTS IN NEW YORK CITY TODAY!**

**Don Skinner, Manager, Sales & Service**  
**Owen Kavanagh, Asst. Manager, Sales & Service**  
**Larry Govic, District Sales Manager**  
**Harry Nelson, Asst. District Sales Manager**  
**Roy Anderson, Area Sales Representative**  
**Donald Watson, Area Sales Representative**  
**Don Grasing, Sales Representative**  
**Fred Lammer, Jr., Sales Representative**  
**Joe Eichner, Sales Representative**  
**Hector DeSotza, Regional Manager-Intermodal Sales**  
**Jack Kelly, Area Sales Representative (West Haven, CT)**



**SANTA FE SALES & SERVICE CENTER**  
 708 THIRD AVENUE, NEW YORK, NY 10017 • PHONE: 212-953-1320

**WELCOME TO THE  
SEVENTY-FIRST ANNUAL DINNER**

OF

**THE TRAFFIC CLUB OF NEW YORK**  
(INCORPORATED)

**GRAND BALLROOM**

**GRAND HYATT HOTEL**



**DINNER COMMITTEE**

Herbert J. Madden, Chairman  
 Eugene D. Onieal, Vice Chairman

G.W. Armstrong	J.J. Murphy
H.A. Buono	J.W. Peterson
M.E. Johnson	A.D. Redmond
K.J. Lombardo	W.B. Rose
L.W. Mottley	G.A. Sansverie
J.L. MOUNT	J.T. Walker

Eugene V. Fitzpatrick, **President**

**FEBRUARY 26, 1981**

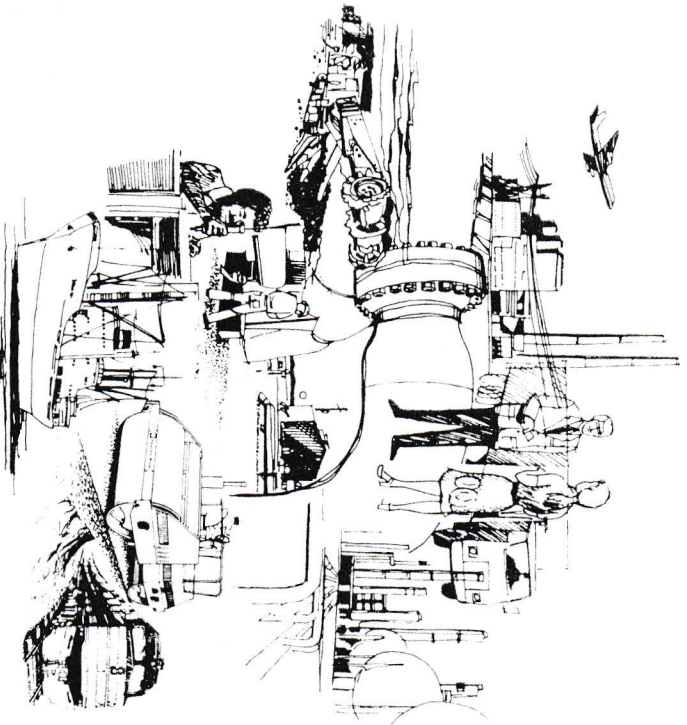

## **servicing the transportation industry needs**

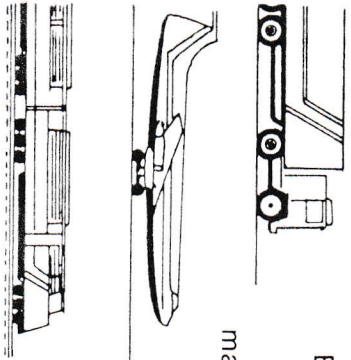

Be it highways, railroads or runways, Ingersoll-Rand products help to build and maintain them. In fact, nearly every product or service used in the transportation industry somewhere involves the use of Ingersoll-Rand equipment in its manufacture or maintenance.

 **INGERSOLL-RAND**

**We hope that you enjoy the program we have arranged, and thank you for being a part of the Traffic Club of New York Seventy-First Annual Dinner**



**Herbert J. Madden, Chairman  
ANNUAL DINNER COMMITTEE**

**Michael J. Walsh, Chairman  
PRESIDENTS RECEPTION  
COMMITTEE**

**Eugene D. Onieal, Chairman  
ANNUAL DINNER JOURNAL**

## PRESIDENTS GUEST COMMITTEE

Michael J. Walsh, Jr.  
Chairman

W.H. Magrath

Vice Chairmen

F.L. Mervin

A.E. Baylis  
J.H. Blair  
F.H. Coogan  
E.J. Dean  
W.T. Delmator  
E.L. Erickson  
F.C. Forward  
H.H. Huston  
W.J. Honan, Sr.  
E.W. Johnson  
J.J. McBride  
A.G. Milligan  
J.P. Monks

E.F. Mundy

R.E. Murphy  
J.W. Peterson  
R.A. Pepper  
J.A. Punola  
A.D. Redmond  
F.C. Reisse  
W.H. Rogers  
G.A. Sansverie  
T.J. Scholtz  
J.G. Sweet  
C.H. Wager  
J.T. Walker  
C.L. Worth

## PRESIDENT



**EUGENE V. FITZPATRICK**

## OFFICERS

### President

Eugene V. Fitzpatrick

### First Vice President

William B. Rose

### Second Vice President

Donald F. Hagen

### Third Vice President

Lawrence W. Mottley

### Secretary

John W. Peterson

### Treasurer

Raymond Schifferdecker

## DIRECTORS

George J. Brunner, Chairman

G.W. Buryea  
A.J. Corbett, Jr.  
N.R. Cosenitino  
E.L. Erickson  
M.L. Govic  
Armond Heerman

C.J. Lancaric  
W.H. Magrath  
J.P. Martell  
J.P. Monks  
J.L. Mount  
G.A. Sansverie

## LIBRARIAN

Edward G. Harrison

All Signals  Are GO - East or West...

**CLIPPER EXPRESS Piggyback**  
Brings the WEST COAST

Closer To

**NEW YORK and  
NEW JERSEY**

CLIPPER EXPRESS Piggyback—on the fast track all the way—gets you less than TrailerLoad and Trailerloads to and from the West Coast in good time. It's the fastest, easiest way to speed your shipments into and out of New York and New Jersey.

Modern in every respect, Clipper's new terminal in Jersey City is moored after Clipper's many other local terminals from coast to coast. Loading docks on the 400 foot pier, the 6 1/2-acre site allow for 50% a month in the location next to the Garden State and other piggyback ramps speeds handling of freight. High intensity lighting, sturdy perimeter fencing, main gate control, as well as efficient, thorough surveillance assure 24-hour security control. Let Clipper Express tell you how to get the Piggyback Connection to fast, safe service on all your Less Than Trailerload and Trailerload shipments. Call or write today.

**DIRECT DAILY SERVICE**  
\* FROM ALL points in the East and Midwest TO AND FROM ALL points in Arizona, California, Nevada, Oregon, Utah and Washington.  
\* From the East and Midwest to Alaska, Hawaii and major cities in British Columbia.

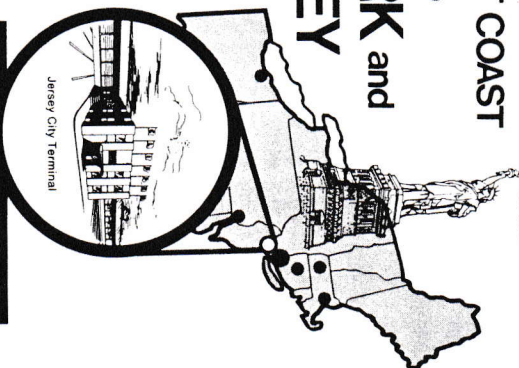

**To Get Express Service  
On All Your Shipments  
Call CLIPPER EXPRESS**  
In NEW YORK Call 212-675-6510  
In NEW JERSEY Call 201-435-0400  
**For Fast Pickup Call Dispatcher Direct**  
In NEW YORK Call 212-267-4621  
In NEW JERSEY Call 201-435-5193

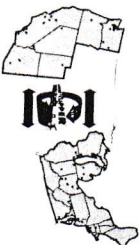

**CLIPPER EXPRESS**  
390 New County Road, Jersey City, NJ 07307

## COMMITTEES — 1980-1981

### BUDGET AND FINANCE

William B. Rose, Chairman  
A.J. Corbett, Jr., Vice Chairman

J.J. Fay  
E.V. Fitzpatrick  
D.F. Hagen  
Armond Heerman  
H.J. Madden  
L.W. Mottley  
E.D. Onieal  
L.J. Welter  
V.H. Wilson

### DINNER

Herbert J. Madden, Chairman  
Eugene D. Onieal, Vice Chairman

G.W. Armstrong  
H.A. Buono  
M.E. Johnson  
K.J. Lombardo  
L.W. Mottley  
J.L. Mourt  
J.J. Murphy  
J.W. Peterson  
A.D. Redmond  
W.B. Rose  
G.A. Sansverie  
J.T. Walker

### EDITORIAL AND BULLETIN

Irving S. Rushboldt, Editor

### Feature Writers

N.R. Cosentino  
M.L. Govic  
D.F. Hagen  
A.J. Hartzell  
J.J. McBride  
L.J. Miskell  
L.J. Pim  
F.M. Zitto

### Photographer

M.J. Riordan

### EDUCATIONAL

Sal G. Fiore, Chairman

Co-Chairmen  
J.H. Blair F.M. Zitto

R.J. Janer  
G.W. Kirtley  
James Deehan  
Bruno Leporati  
P.V. Kline  
C.L. Smith

## WE'VE MERGED. IN ORDER TO FORM A MORE PERFECT UNION.

Our end-to-end merger was a perfect match right from the beginning. By joining Burlington Northern and the St. Louis-San Francisco Railway, we can offer shippers direct, single-line service from Winnipeg down to Galveston, and from Vancouver to Pensacola. This expanded service area should provide improved efficiency, over the long haul. The new Burlington Northern.

It's better for everyone.

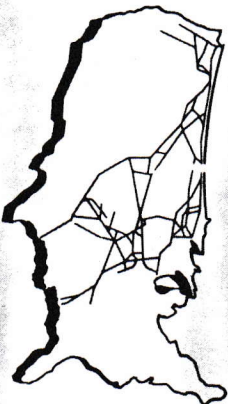

**BN**  
BURLINGTON  
NORTHERN

**FRISCO**

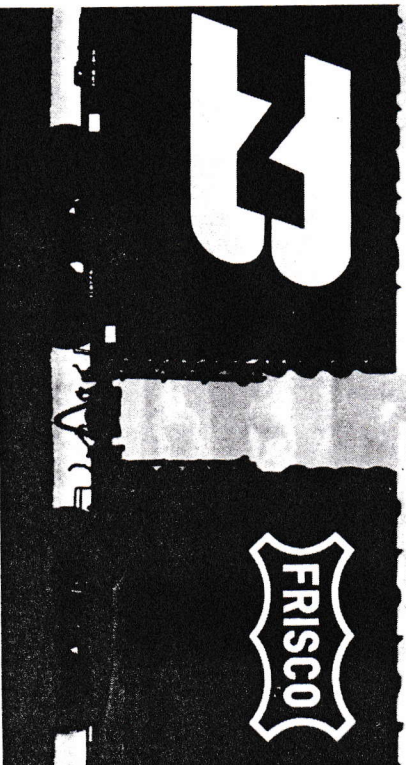

**ENTERTAINMENT**

Wayne P. Cosenino, Chairman  
Michael J. Riordan, Vice Chairman

- |                  |                  |                    |
|------------------|------------------|--------------------|
| G.W. Armstrong   | A. Herman        | R.R. Milne         |
| C.J. Bagnall     | S.W. Hoback      | E.R. Monahan       |
| G.T. Barker      | Alan Hudson      | F.L. Mullady, Jr.  |
| M.S. Bernhardson | H.W. Jones       | B.A. Oberlander    |
| H.A. Buono       | C.F. Kauter      | J.H. O'Brien       |
| N.R. Cosenino    | D.C. Killeary    | R.M. Ortega        |
| H.J. De Soiza    | J.R. Knoblock    | R.A. Pepper        |
| D.A. Du Fault    | T.J. Knuth       | R.R. Riola         |
| R.J. Everett     | M. Kutney        | G.A. Sansverie     |
| E.J. Fitzgerald  | C.J. Lancaric    | A.M. Scarpa        |
| S.E. Franey      | J.E. Lappin      | J.B. Scott         |
| T.P. Gallaway    | R.R. Lindley     | S.J. Seelentfreund |
| T.R. Gilbert     | W.H. Magrath     | F.L. Skinner, Jr.  |
| Milan Govic      | G.L. McGrath     | R.E. Williams      |
| D.J. Grasing     | J.J. McGuigan    | Herbert Wilson     |
| R.N. Grove       | D.T. McShane     | J.M. Zachara       |
| D.F. Hagen       | R.A. Mecchella   | E.J. Zarrillo      |
| A.E. Hayes       | J.J. Medley, Jr. |                    |

**HISTORICAL AND FINE ARTS**

Herbert Stevenson Jr., Chairman  
Edward J. Zarrillo, Vice Chairman

- |                |               |
|----------------|---------------|
| H.J. Anderson  | J.W. Markert  |
| R.J. Denenholz | J.E. McNamara |
| W.S. Gonda     | R.M. Ortega   |

**HOUSE**

D.F. Hagen, Chairman  
L.W. Mottley, Vice Chairman

- |                  |                  |                  |
|------------------|------------------|------------------|
| J.A. Callaway    | John Helm        | W.F. Pick        |
| K.B. Coleman     | W.F. Hoffman     | M.A. Palumbo     |
| W.P. Cosenino    | D.C. Killeary    | Hernan Poza, Jr. |
| Paul Di Bari     | E.B. Limongelli  | A.D. Redmond     |
| T.A. Downes, Jr. | R.R. Lindley     | M.J. Riordan     |
| W.S. Felmy       | J.J. Medley, Jr. | F.D. Robertie    |
| A.J. Fenaroli    | C.S. Merritt     | D.O. Schrone     |
| T.P. Hart        | Katre Turban     | P.A. Terrells    |

**Congratulations  
Bill Rose,**

New president of the  
Traffic Club of New York.

We're proud of you!



Witco Chemical Corporation  
277 Park Avenue, New York, N.Y. 10017

## PUBLIC AFFAIRS

E.V. Fitzpatrick, Chairman

F.H. Coogan  
L.L. Dintiman

H.J. Madden  
E.D. Onieal

## PUBLICITY

T.A. Downes, Jr., Chairman

Vice-Chairmen

D.F. Collins  
J.P. Deehan  
J.R. Morton

J.J. Russell  
I.M. Schofield

## RECEPTION

Walter J. Gonda, Chairman

Vice Chairmen  
J.C. Gustus

E.F. Hogan

R.E. Anderson  
John Bell  
W.T. Boettigheimer  
R.N. Buchheit  
W.C. Coleman  
F.F. Donovan  
F.A. DZurilla  
F.A. Fierro  
J.J. Fitzgerald  
B.C. Fuller  
Milan Govic  
D.J. Grasing  
E.R. Herlthy  
A.M. Herman

W.F. Hoffman  
Alan Hudson  
C.E. Kessler  
M. Kulney  
R.M. Larkin  
W.J. Laundrie  
R.C. Lundin  
R.J. Malette  
P.J. Maloney  
J.T. Meany  
R.A. Mecchella  
J.J. Medley, Jr.  
R.E. Murphy

R.A. Pepper  
J.J. Ruivo  
E.P. Ryan  
R.P. Ryan  
Axel Schmid  
J.B. Scott  
V.R. Simmons  
J.F. Skane  
P.G. Thaler  
Emil Tripp  
W.M. Weaver  
G.T. Weber  
J.A. Wozniak

## SPEAKERS

A.G. Anderson, Chairman Emeritus  
A.E. Baylis, Chairman  
M.J. Walsh, Vice Chairman

G.J. Brunner  
R.E. Heine  
F.L. Merwin

E.F. Mundy  
J.W. Peterson  
T.K. Turner

We carry your goods



like they're our own.

Soo Line  
Railroad  
Company



The quality connection



## JOURNAL

Eugene D. Orietal, Chairman  
Herbert J. Madden, Vice Chairman

G.W. Armstrong	L.W. Mottley
M.S. Bernhardtson	J.L. Mount
H.A. Buono	J.J. Murphy
J.J. Fay	J.W. Peterson
T.P. Hart	A.D. Redmond
M.E. Johnson	W.B. Rose
K.J. Lombardo	G.A. Sansverie
K. McLaughlin	J.T. Walker
W.H. Magrath	

### LEGAL ADVISORY

Wilbert T. Patterson, Chairman  
T.J. Beener

### MEMBERS' ADVISORY

Joseph R. Knoblock, Chairman

#### Vice Chairmen

R.C. Bell	L.S. Truslow	F.X. Biasi
F.C. Atherton	V.J. Landi	J.F. Peyton
E.F. Bollen	E.L. Leonoro	J.A. Punola
C.F. Browning	R.R. Lindley	S.J. Seelentfreund
T.A. Downes, Jr.	E.G. Loeffler	H. Stevenson, Jr.
D.J. Grasing	J.T. Meany	J.L. Tompkins
B.J. Hammons	R.R. Morin	H.T. Wilson

### MEMBERSHIP

Daniel C. Killeary, Chairman

W.T. Boettigheimer	W.B. Rose, Jr.
J.P. Dressel	T.J. Scholtz
Arthur Eszes, Jr.	J.J. Sussen, Jr.
J.A. Kuhlmeier	J.J. Walsh
J.A. Lane	R.E. Williams
J.P. McGreevey	L.J. Zerillo
W.H. Magrath	W.R. Ziegler
J.J. Medley, Jr.	

**From Friends  
at INMONT**

Inmont Corporation  
1255 Broad Street  
Clifton, New Jersey, 07015

**SPORTS**

**BOWLING COMMITTEE**

H.A. Buono, Chairman

**GOLF**

L.J. Zerillo, Chairman

W.E. Studer, Vice Chairman

- |                   |                   |                    |
|-------------------|-------------------|--------------------|
| G.T. Barker       | D.J. Grasing      | J.E. McNamara      |
| John Bell         | D.F. Hagen        | B.A. Oberlander    |
| M.S. Bernhardtson | A.E. Hayes        | E.D. Onieal        |
| H.J. Blair        | Alan Hudson       | R.M. Ortega        |
| G.W. Bunyea       | R.A. Jordan       | R.A. Pepper        |
| H.A. Buono        | J.R. Knoblock     | H.F. Quick         |
| J.A. Callaway     | T.J. Knuth        | T.W. Quinlan       |
| W.C. Coleman      | R.M. Larkin       | M.J. Riordan       |
| D.F. Collins, Jr. | S.J. Maddalena    | H.C. Scherer       |
| J.J. Collins      | H.J. Madden       | I.S. Schofield     |
| L.J. Comple       | A.J. Maddin       | T.J. Scholtz       |
| B.R. Costello     | J.J. Malone       | S.E. Seelentfreund |
| H.J. DeSoza       | P.J. Maloney      | J.F. Skane         |
| R.J. Everett      | J.W. Markert      | H.W. Swank         |
| F.A. Ferro        | R.A. Mecchella    | H.G. Thone         |
| R.R. Forrest      | RE. Mullady       | RE. Williams       |
| Harry Gershoff    | F.E. Mullady, Jr. | V.J. Wilson        |
| Ben Giaretta      | R.E. Murphy       | John Wojewnik      |
| M. Govic          | J.J. McGuigan     |                    |

**VISITING**

M.J. Riordan, Chairman

E.L. Leonaro, Vice Chairman

M. Govic

T.P. Hart

W.P. Cosentino

**GUEST SPEAKER**



**DR. ISAAC ASIMOV**  
**SCIENTIST-FUTURIST**

**Congratulations  
To The  
Incoming Officers  
Of  
The Traffic Club of New York**

- |                       |                      |                             |
|-----------------------|----------------------|-----------------------------|
| President             | —William B. Rose     | —Witco Chemical Corporation |
| First Vice-President  | —Donald F. Hagen     | —Soo Line Railroad          |
| Second Vice-President | —Lawrence W. Mottley | —Immont Corporation         |
| Third Vice-President  | —Lewis J. Welter     | —Hapag-Lloyd                |

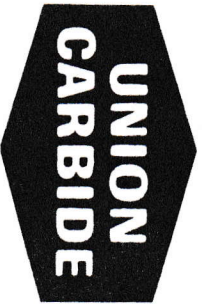

**UNION CARBIDE CORPORATION**

**Congratulations  
To The  
Incoming Officers  
of  
The Traffic Club of New York**

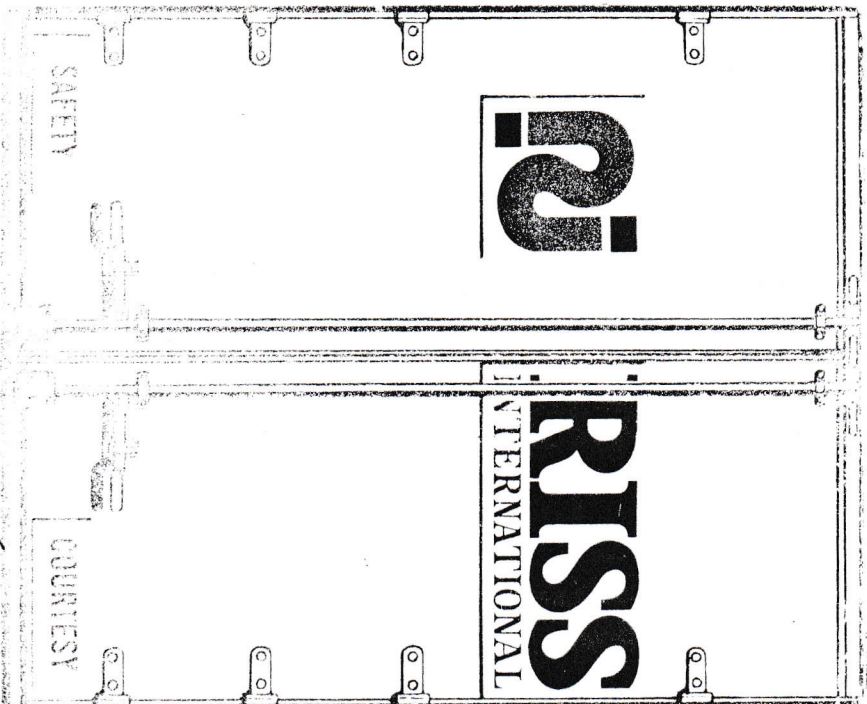

# Best Wishes for 1981!

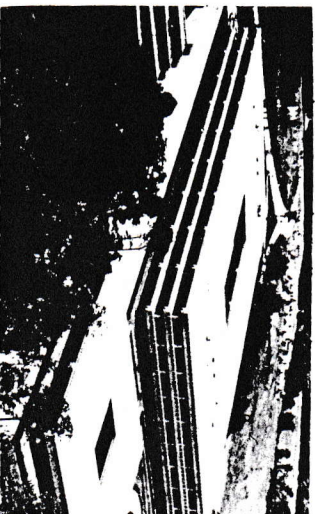
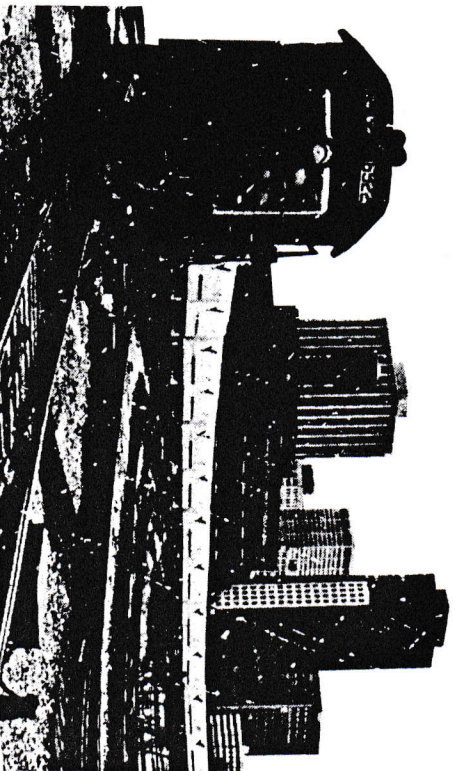

American Can is an integrated company engaged primarily in consumer products and distribution; containers and packaging; resource recovery and chemicals. With revenues of \$4.5 billion, we employ more than 55,000 people at 700 locations worldwide. Over 100,000 stockholders own more than 20 million shares in the corporation. Our own employees illustrate our commitment to value in its broadest sense: to the consumer through better quality and service; to the company by increased productivity; to society through concern for the community and the environment; to themselves in job enrichment and good pay.



# Lease and Sale of Tank Cars and Center Flow<sup>®</sup> Covered Hopper Cars

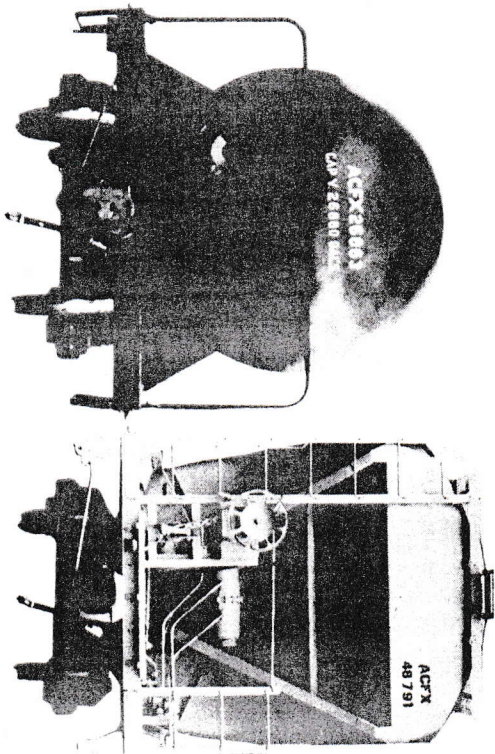

**SALES OFFICES**  
**HEADQUARTERS**  
 630 North Second Street, St. Charles, MO  
**NORTH-EASTERN**  
 One Executive Drive, Fort Lee, NJ  
**EASTERN**  
 750 Third Avenue, New York, NY  
**MID-EASTERN**  
 One Berea Commons, Berea, OH  
**MID-WESTERN**  
 10 South Riverside Plaza, Chicago, IL  
**CENTRAL**  
 331 Westport Plaza, St. Louis, MO

**SOUTHERN**  
 450 North Belt East, Houston, TX  
**WESTERN**  
 One Market Plaza, San Francisco, CA  
**CANADIAN**  
 1117 St. Catherine St. West, Montreal,  
 Quebec, Canada

**SERVICE PLANTS**  
 Baku, MS • Longview, TX • North Kansas City, MO  
 Red Bank, WV • East St. Louis, IL • Mead, PA



Shippers  
Car Line  
Division

# “Here’s to You!”

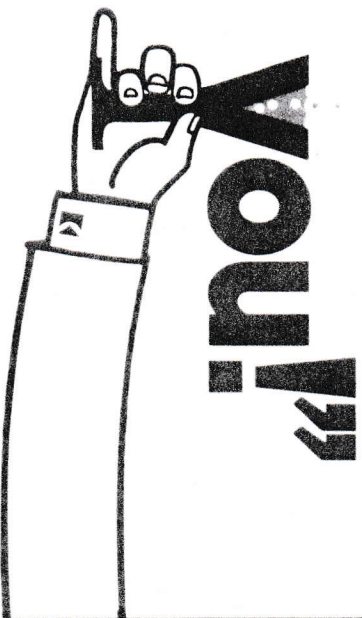

Each year we welcome this opportunity to toast you, our American friends.

We’re here to serve you. And serving you well is the best way we know to help each other grow.

As the rail arm of Canadian Pacific—which is celebrating its 100th Anniversary in 1981—we’ve built up the experience, equipment and connections to keep traffic flowing between our two great countries.

Let’s toast that friendly relationship and the fine fellowship we share tonight.

**CP Rail**  
 A division of Canadian Pacific

# NW

For information and assistance,  
contact the office of:

John P. Monks  
Assistant Vice President —  
Sales  
Eastern Region

Norfolk and Western  
Railway Company  
522 Fifth Avenue/13th Floor  
New York, New York 10036

Telephone (212) 869-0400

**Service  
and  
Dependability**



To move freight, you need a GOOD connection.

*Saludas*  
AND  
*Best Wishes*

FROM



Represented by  
PUERTO RICO MARINE MANAGEMENT, INC.  
ELIZABETH, N.J.

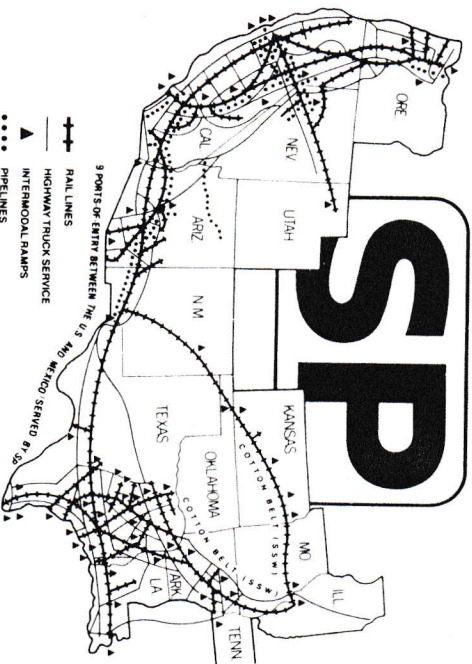

## We're committed to serving your freight transportation needs...

- with an expanded 14,000 mile rail system
- with 30,000 miles of highway truck services
- with total intermodal capabilities from the Mississippi River to the West Coast
- with petroleum products pipelines serving six Western states
- and with people who want to do a better job in serving your transportation needs

In New York, call **(215) 557-9555**,

**W. T. "Bill" Delmarter** Regional Sales Manager  
**Wayne H. Matzen** Area Sales Manager



**Southern Pacific Transportation Company**

## Introducing UTLX covered hopper cars.

You'll find plenty of features in these new UTLX hopper cars. They're the latest in manufacturing and materials technology. Also backed by one of the best known names in the rail car transportation industry, Union Tank Car Company.

**Choose from five models and capacities.** Whether you're shipping grain, plastic pellets, salt, sand or other dry bulk commodities, you'll find a UTLX hopper car built for you. From 3,000 to 5,800 cubic feet capacities. Each model has been carefully designed for simple, reliable operation—from hatch

cover to outlet gate. And each is precision-fabricated to give you strength, but not extra weight.

These new designs and built hopper cars are available now at a modern, highly automated fabricating plant in Cleveland, Texas.

To learn more about the choices, features and support that make them a special value, call your UTLX district representative or send for our product specification and literature. Write to: Union Tank Car Company, an affiliate of Tank Union Corporation, 111 W. Jackson Blvd., Chicago, IL 60604.

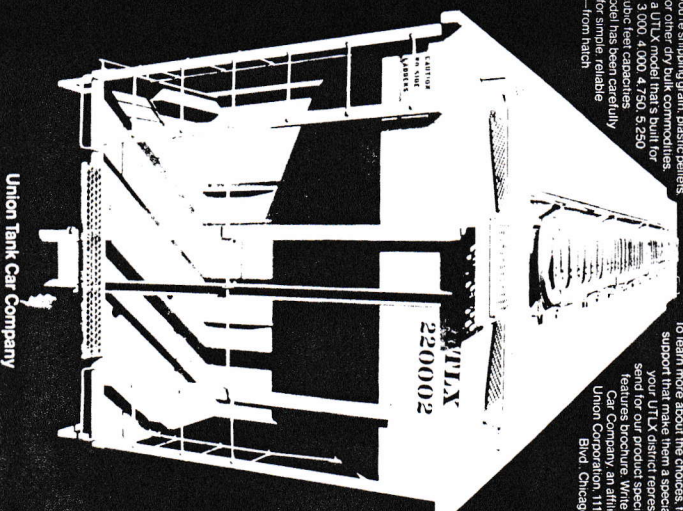

Union Tank Car Company



# The Canadian Connection

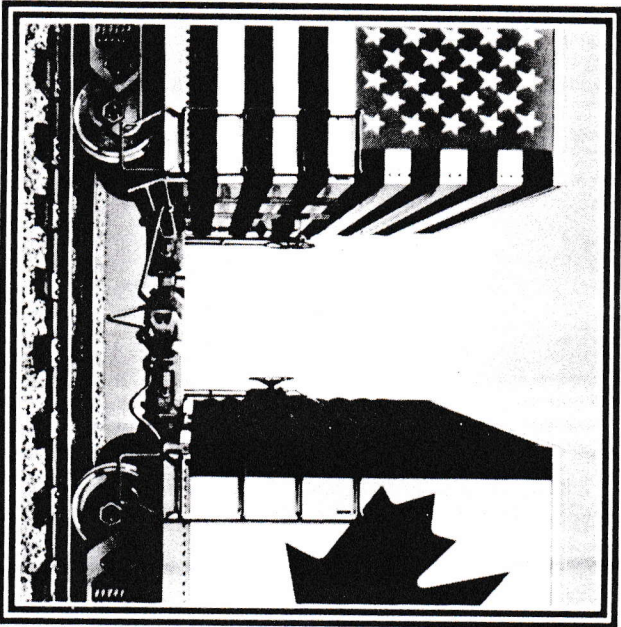

**1906-1981**

Congratulations to the Traffic Club of New York, celebrating its Diamond Anniversary this year. Meeting good neighbours is part of the annual dinner program activities, and CN Rail is proud to play an important distribution role between friendly neighbours.

We intend to keep the road clear for continued progress between our two great countries, letting the "Canadian Connection" work for the benefit of us all. Good Neighbours — Good Business!

# CN RAIL GT

# REGIONAL

IMPORT & EXPORT TRUCKING CO., INC.

PROVIDING THE FOLLOWING SERVICES IN MODERN FACILITIES LOCATED IN PRIME FREE ZONE AREAS, ADJACENT TO PIERS, RAIL RAMPS AND MAJOR ARTERIES:

- Consolidation (Package and Fluid Load)
- Distribution (Rail Cars and Trailers)
- Import and Export Handling
- Warehousing (Including Pick and Pack)
- Commercial Zone Trucking
- Complete Computerized Operations
- Truck Rental (Short and Long Term)
- Low Insurance Rate
- Complete Security
- Experience and KNOW HOW



# REGIONAL

TRANSPORTATION COMPANY, INC.

CONTRACT CARRIAGE TAILORED TO CUSTOMERS' NEEDS IN NEW SLEEPER CABS AND NEW HI-CUBE TRAILERS

600 SECAUCUS ROAD  
SECAUCUS, NJ 07094

**PAT NASTRO**  
President

**KENNETH J. BURROWES**  
Executive Vice President

New York Direct Lines  
(212) 227-2838

New Jersey Lines  
(201) 865-4100



Congratulations to the  
Traffic Club of New York

on your  
75th Birthday  
1906 — 1981

from your friends at

HALLS MOTOR TRANSIT  
COMPANY

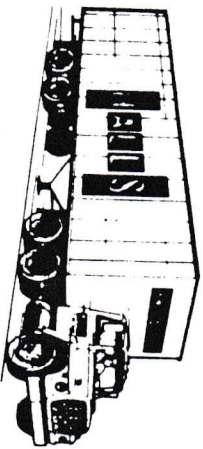

# FUEL SAVER

We can say it with pardonable pride and factual support — railroads are the most fuel efficient means of land transport.

For example, it takes 3 or 4 times more fuel to move a ton of freight by truck as by rail.

And we're going all out to do even better.

We've installed special fuel saver devices on our locomotives. And our new diesels will be even more efficient.

We've also instituted a number of operational changes to maximize fuel efficiency without reducing performance. Such as computer simulation tests where experienced engineers pit themselves against tell-tale electronic performance checks.

Saving fuel is everyone's business.

Vitality so. We're determined to do our part —

**We can handle it.**

the Union Pacific  
railroad people.

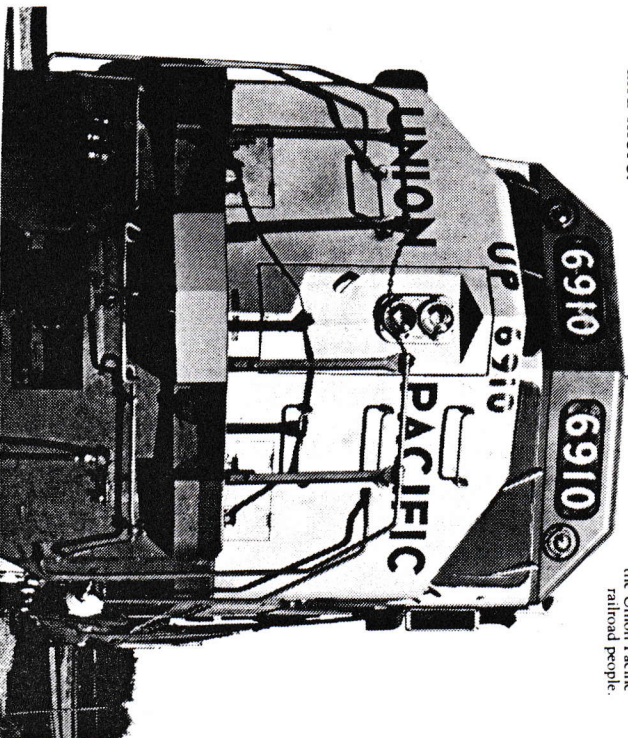



# You Can Depend on EMERY.

The only shipping service you'll ever  
need... whatever your needs.

**EMERY**  
Air Freight



## 605 GOOD REASONS.....

LAMOILLE VALLEY RAILROAD COMPANY									
Reporting Marks and ACI Nos. — "LVRC", 0-452									
Uniform Alphabetic and Numeric Code — "LVRC", -452									
GENERAL OFFICE AND NO. 1 STATION: 100 NORTH VERMONT ST., VERMONT, VT. 05401									
GENERAL OFFICE AND NO. 2 STATION: 100 NORTH VERMONT ST., VERMONT, VT. 05401									
GENERAL OFFICE AND NO. 3 STATION: 100 NORTH VERMONT ST., VERMONT, VT. 05401									
GENERAL OFFICE AND NO. 4 STATION: 100 NORTH VERMONT ST., VERMONT, VT. 05401									
GENERAL OFFICE AND NO. 5 STATION: 100 NORTH VERMONT ST., VERMONT, VT. 05401									
GENERAL OFFICE AND NO. 6 STATION: 100 NORTH VERMONT ST., VERMONT, VT. 05401									
GENERAL OFFICE AND NO. 7 STATION: 100 NORTH VERMONT ST., VERMONT, VT. 05401									
GENERAL OFFICE AND NO. 8 STATION: 100 NORTH VERMONT ST., VERMONT, VT. 05401									
GENERAL OFFICE AND NO. 9 STATION: 100 NORTH VERMONT ST., VERMONT, VT. 05401									
GENERAL OFFICE AND NO. 10 STATION: 100 NORTH VERMONT ST., VERMONT, VT. 05401									
GENERAL OFFICE AND NO. 11 STATION: 100 NORTH VERMONT ST., VERMONT, VT. 05401									
GENERAL OFFICE AND NO. 12 STATION: 100 NORTH VERMONT ST., VERMONT, VT. 05401									
GENERAL OFFICE AND NO. 13 STATION: 100 NORTH VERMONT ST., VERMONT, VT. 05401									
GENERAL OFFICE AND NO. 14 STATION: 100 NORTH VERMONT ST., VERMONT, VT. 05401									
GENERAL OFFICE AND NO. 15 STATION: 100 NORTH VERMONT ST., VERMONT, VT. 05401									
GENERAL OFFICE AND NO. 16 STATION: 100 NORTH VERMONT ST., VERMONT, VT. 05401									
GENERAL OFFICE AND NO. 17 STATION: 100 NORTH VERMONT ST., VERMONT, VT. 05401									
GENERAL OFFICE AND NO. 18 STATION: 100 NORTH VERMONT ST., VERMONT, VT. 05401									
GENERAL OFFICE AND NO. 19 STATION: 100 NORTH VERMONT ST., VERMONT, VT. 05401									
GENERAL OFFICE AND NO. 20 STATION: 100 NORTH VERMONT ST., VERMONT, VT. 05401									
GENERAL OFFICE AND NO. 21 STATION: 100 NORTH VERMONT ST., VERMONT, VT. 05401									
GENERAL OFFICE AND NO. 22 STATION: 100 NORTH VERMONT ST., VERMONT, VT. 05401									
GENERAL OFFICE AND NO. 23 STATION: 100 NORTH VERMONT ST., VERMONT, VT. 05401									
GENERAL OFFICE AND NO. 24 STATION: 100 NORTH VERMONT ST., VERMONT, VT. 05401									
GENERAL OFFICE AND NO. 25 STATION: 100 NORTH VERMONT ST., VERMONT, VT. 05401									
GENERAL OFFICE AND NO. 26 STATION: 100 NORTH VERMONT ST., VERMONT, VT. 05401									
GENERAL OFFICE AND NO. 27 STATION: 100 NORTH VERMONT ST., VERMONT, VT. 05401									
GENERAL OFFICE AND NO. 28 STATION: 100 NORTH VERMONT ST., VERMONT, VT. 05401									
GENERAL OFFICE AND NO. 29 STATION: 100 NORTH VERMONT ST., VERMONT, VT. 05401									
GENERAL OFFICE AND NO. 30 STATION: 100 NORTH VERMONT ST., VERMONT, VT. 05401									
GENERAL OFFICE AND NO. 31 STATION: 100 NORTH VERMONT ST., VERMONT, VT. 05401									
GENERAL OFFICE AND NO. 32 STATION: 100 NORTH VERMONT ST., VERMONT, VT. 05401									
GENERAL OFFICE AND NO. 33 STATION: 100 NORTH VERMONT ST., VERMONT, VT. 05401									
GENERAL OFFICE AND NO. 34 STATION: 100 NORTH VERMONT ST., VERMONT, VT. 05401									
GENERAL OFFICE AND NO. 35 STATION: 100 NORTH VERMONT ST., VERMONT, VT. 05401									
GENERAL OFFICE AND NO. 36 STATION: 100 NORTH VERMONT ST., VERMONT, VT. 05401									
GENERAL OFFICE AND NO. 37 STATION: 100 NORTH VERMONT ST., VERMONT, VT. 05401									
GENERAL OFFICE AND NO. 38 STATION: 100 NORTH VERMONT ST., VERMONT, VT. 05401									
GENERAL OFFICE AND NO. 39 STATION: 100 NORTH VERMONT ST., VERMONT, VT. 05401									
GENERAL OFFICE AND NO. 40 STATION: 100 NORTH VERMONT ST., VERMONT, VT. 05401									
GENERAL OFFICE AND NO. 41 STATION: 100 NORTH VERMONT ST., VERMONT, VT. 05401									
GENERAL OFFICE AND NO. 42 STATION: 100 NORTH VERMONT ST., VERMONT, VT. 05401									
GENERAL OFFICE AND NO. 43 STATION: 100 NORTH VERMONT ST., VERMONT, VT. 05401									
GENERAL OFFICE AND NO. 44 STATION: 100 NORTH VERMONT ST., VERMONT, VT. 05401									
GENERAL OFFICE AND NO. 45 STATION: 100 NORTH VERMONT ST., VERMONT, VT. 05401									
GENERAL OFFICE AND NO. 46 STATION: 100 NORTH VERMONT ST., VERMONT, VT. 05401									
GENERAL OFFICE AND NO. 47 STATION: 100 NORTH VERMONT ST., VERMONT, VT. 05401									
GENERAL OFFICE AND NO. 48 STATION: 100 NORTH VERMONT ST., VERMONT, VT. 05401									
GENERAL OFFICE AND NO. 49 STATION: 100 NORTH VERMONT ST., VERMONT, VT. 05401									
GENERAL OFFICE AND NO. 50 STATION: 100 NORTH VERMONT ST., VERMONT, VT. 05401									

- 600 Cushion Cars Available for Unrestricted Paper Loading
- 601 - Coordinated Schedules Speed your Freight
- 602 - Careful Handling — Avoid Hump Yards
- 603 - All Weather Service — No Snow Delays
- 604 - Location Reports Furnished on Request
- 605 - We're a Shipper-Owned, Shipper-Oriented Railroad  
Responsive to Your Needs, so

.....ROUTE IT OUR WAY

**Lamotte Valley Railroad Company**

VERMONT: 100 N. VERMONT ST., VERMONT, VT. 05401  
NEW YORK: 100 N. VERMONT ST., VERMONT, VT. 05401  
WASHINGTON: 100 N. VERMONT ST., VERMONT, VT. 05401

**ONLY . . . Western Carloading**

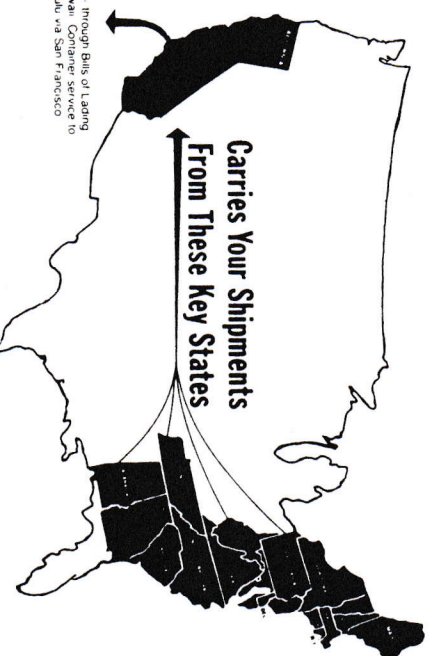

And — through Bills of Lading to Hawaii. Container service to Honolulu via San Francisco



**To California and Hawaii ONLY**

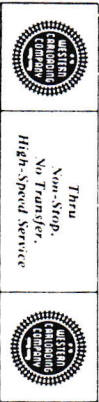

**GENERAL OFFICE**  
450 Seventh Avenue, New York, N. Y. 10001  
Phone: 239-2266



ASHVILLE • ATLANTA • BALTIMORE • BIRMINGHAM • BOSTON • CHARLOTTE • CHATTANOOGA  
COLUMBUS • GREENVILLE • FRESNO • GREENSBORO • KNOXVILLE • LOS ANGELES • LYNCHBURG  
MEMPHIS • NASHVILLE • NEWARK • NEW YORK • NO HAVEN • PHILADELPHIA • PITTSBURGH  
PANTUCKET • SAN DIEGO • SAN FRANCISCO • SPRINGFIELD • SYRACUSE • WORCESTER

Compliments

of



**MCLEAN TRUCKING CO.**

STEVE BURG  
CARL FLICKINGER  
ED LAKE  
GEORGE WEBER

the "New,"

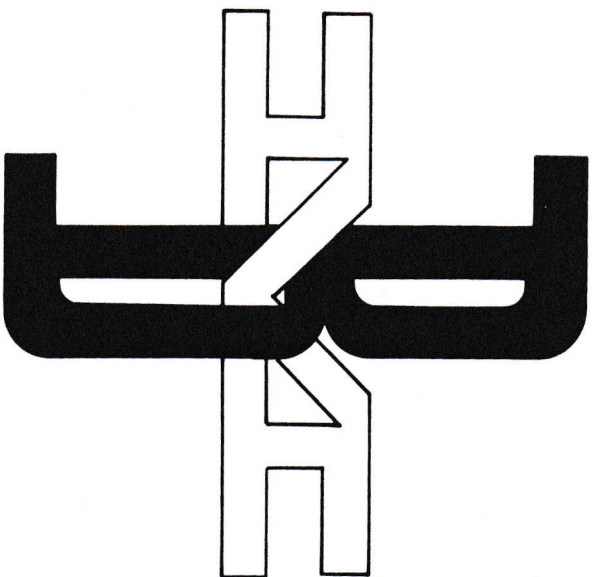

CONGRATULATES THE  
INCOMING OFFICERS  
OF THE TRAFFIC CLUB  
OF NEW YORK, INC.

**GUESTS  
UPPER DAIS**

(Reading from Left to Right)

- 1964 STEPHEN TINGHITELLA  
Editorial Director, Traffic Management
- 1964 CHARLES H. WAGER  
Retired General Traffic Manager, Shell Oil Company
- 1958 HORACE H. HUSTON  
Retired General Traffic Manager, American Can Company
- 1957 WILLIAM J. HONAN, SR.  
Retired Assistant Freight Traffic Manager,  
The Baltimore & Ohio Railroad
- WALTER T. FREE  
President, The Traffic Club of Newark
- WILLIAM H. WHALEN, JR.  
President, Whalen's Moving & Storage Company
- 1974 ARCHER G. MILLIGAN  
Retired Director of Transportation, Sperry & Hutchinson Company
- 1976 JOHN J. McBRIDE  
Transportation Manager, Greater New York Blood Program
- LEWIS J. WELTER  
Senior Vice President — Marketing, Hapag-Lloyd (America) Inc.
- MAURICE THIBEAULT  
Vice President and General Manager, Interstate System
- LAWRENCE W. MOTTLEY  
Third Vice President, The Traffic Club of New York, Inc.
- CHARLES L. SMITH  
Chairman, Eastern Railroad Association
- 1977 HERBERT J. MADDEN  
Vice President, Clipper Express
- 1979 EUGENE D. ONIEAL  
(ELECT)  
Area Director, Burlington Northern Inc.
- RAYMOND SCHIFFERDECKER  
Treasurer, The Traffic Club of New York, Inc.
- ALFRED H. ODEVEN  
Manager — Transportation East, Western Electric Co., Inc.
- 1970 JOHN W. PETERSON  
Secretary, The Traffic Club of New York, Inc.
- 1978 THOMAS K. TURNER  
Vice President, Transit Services, Inc.
- ROY E. OLSON  
Vice President, American Paper Institute
- ROBERT J. BRAINE  
President, Raritan Traffic Club
- THOMAS BORG  
Senior Vice President — Sales & Marketing, I.M.L. Freight, Inc.
- RUPERT H. ROSE  
General Traffic Manager, Richmond, Fredericksburg & Potomac Railroad Co.
- P. HOWARD CROFT  
President, American Short Line Railroad Association
- ANTHONY QUATTRROCHI  
President, Metropolitan Traffic Association of New York, Inc.

**SPEAKERS**

GEORGE J. BRUNNER, Chairman of Board

\*

**National Anthem**  
SAMUEL W. HOBACK

\*

**INVOCATION**

REV. VINCENT J. McSHANE, PASTOR  
Church of St. Vincent de Paul  
New York, New York

\*

**Presentation of Plaque**  
GEORGE J. BRUNNER

\*

**President**  
EUGENE V. FITZPATRICK

\*

**Guest Speaker**  
DR. ISAAC ASIMOV  
"Transportation in the Future"

**SEATING ARRANGEMENT**

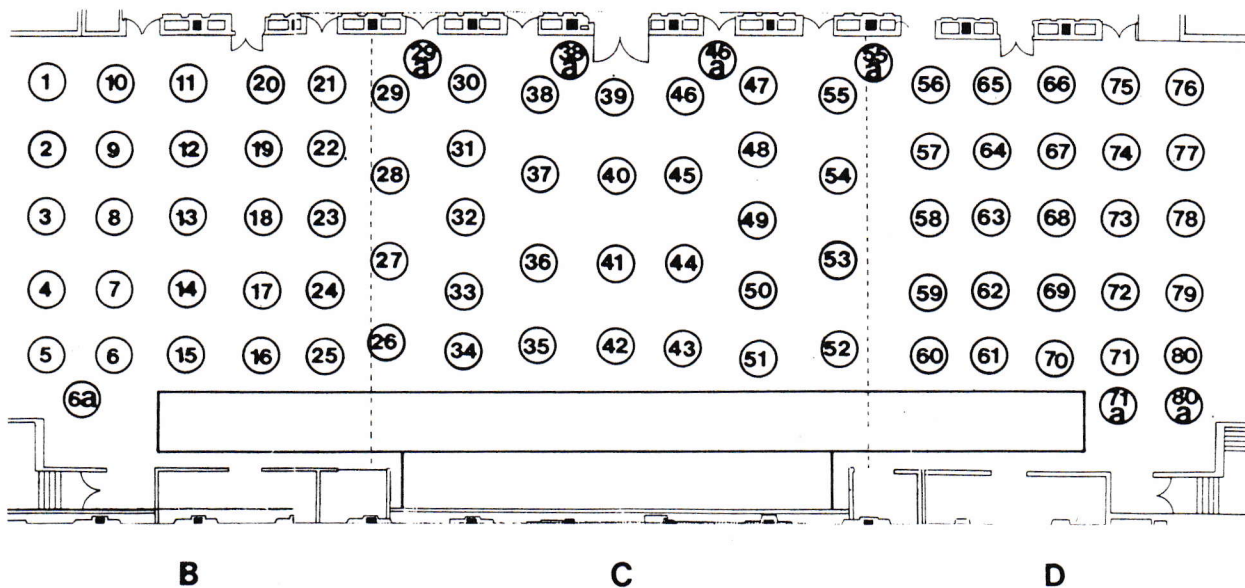

Our People Are Our Strength...



and we're proud to have  
New York Traffic Club's  
President, Gene Fitzpatrick,  
on our team!



**THE FAMILY LINES RAIL SYSTEM**  
We Move Freight... BETTER!

**CHESIEE IS YOUR ENERGY CONNECTION.**

If you are planning plant-site locations for tomorrow talk with Chesiee today. Our right-of-way connects you to 19 billion tons of the proven American energy resource: coal.

Chesiee's team of specialists can work on your behalf by searching a 12 state area, from the Mississippi to the Atlantic, to find the site that's right for you. One that gives you a dependable source of energy, plus an energy-efficient mode of transportation... Chesiee rail transportation.

Since the recent energy crunch Chesiee site selection experts have helped hundreds of industries build, expand or relocate on our lines... to take advantage of our energy connections. Many are burning



coal exclusively in their new power plant systems. This means long-term savings for these industries and their customers.

To make the Chesiee connection, write to Dick Hackmann, Assistant Vice President & General Manager, Real Estate & Industrial Development, Chesiee System Railroads, Baltimore, Maryland 21201. Or, call our toll-free number, 800-638-1944 Ext. 2754, or 301-237-2754.

The energy of the future rides with Chesiee, today.

YOUR NEW PLANT  
HERE.

*Chesiee*  
Track Factories!

THERE ARE AN ESTIMATED  
19 BILLION TONS OF  
RECOVERABLE COAL  
RESERVES IN CHESIEE  
TERRITORY!

FOLLOW THESE TRACKS TO  
PRIME PLANT SITES AND  
PRIME ACCESS TO COAL.



**CHESIEE**  
FOR THE 80'S

Chesiee System Railroads  
The Chesapeake and the Baltimore, The Baltimore and the Maryland Western, Maryland, Delaware

Two Great Rail Systems... Units of CSX Corporation.

**GUESTS  
LOWER DAIS  
(Reading from Left to Right)**

**WILLIAM B. ROSE**  
First Vice President, Traffic Club of New York, Inc.

**WILLIAM S. MCGGRATH**  
Vice President — Marketing Services, Western Pacific Railroad Company

**PAT NASTRO**  
President, Regional Import & Export Trucking Co., Inc.

**H. WAYNE DAVIS**  
Vice President — Sales, Kansas City Southern Lines

**JOSEPH C. SCHELEEN**  
Vice President, The Traffic Service Corporation

**E.S. RISS**  
President, Riss International

**J. HARDCASTLE**  
Director of Distribution Gillette Company

**RICHARD L. RUSHING**  
Vice President — Sales, Illinois Central Gulf Railroad

**C. RICHARD BARNEY**  
President, Rail Car Division, Evans Products Company

**CURT TATHAM**  
Executive Vice President, Rail Car Division,  
Evans Products Company

**W.L. THORNTON**  
President, Florida East Coast Railway Co.

**COLONEL EDWARD I. HICKEY, JR.**  
Chief of Staff, MTMC, Eastern Area

**WILLIAM J. HONAN, JR.**  
Vice President Sales & Marketing, Moller Steamship Co.

**M. KEGETSU**  
General Manager Traffic Department, Mitsui & Co. (U.S.A.) Inc.

**ARTHUR E. IMPERATORE**  
President, A.P.A. Transport Corporation

**RONALD B. PARIETTI**  
President, Traffic Clubs International

**HAROLD H. HALL**  
President, Southern Railway System

**GUESTS - Continued**

**FRANK E. HENNIG**  
President, ITOFCA Inc.

**WILLIAM P. COLLTON**  
President, Western Maryland Railway Co.

**EARLE A. COMPTON**  
Director Corporate Transportation, Scott Paper Co.

**JOHN S. LANAHAN**  
Senior Vice President — Commercial, Chessie System Railroads

**WILLIAM K. SMITH**  
Vice President, General Mills, Inc.

**W.W. STINSON**  
Executive Vice President, CP Rail

**HENRY A. CORREA**  
President, ACF Industries, Inc.

**ROBERT B. CLAYTOR**  
President, Norfolk and Western Railway Company

**J. ROBERT MORTON**  
Vice President, Corporate Transportation and Distribution  
Combustion Engineering, Inc.

**R.E. LAWLESS**  
President, CN Rail

**L.L. DINTIMAN**  
Director Corporate Distribution, Union Carbide Corporation

**L. STANLEY CRANE**  
Chairman and Chief Executive Officer, Conrail

**MICHAEL J. WALSH, JR.**  
Vice President, St. Regis Paper Company

**PRIME F. OSBORN, III**  
Chairman of the Board, CSX Corporation

**DR. ISAAC ASIMOV**  
Guest Speaker

**EUGENE V. FITZPATRICK**  
President, The Traffic Club of New York, Inc.

**GEORGE BRUNNER**  
Chairman of the Board, Traffic Club of New York, Inc.

**REV. VINCENT J. MCSHANE**  
Pastor Church of St. Vincent de Paul New York, New York

## GUESTS — Continued

**C.F. POLZER**  
Executive Vice President, Wico Chemical Corporation

**LAWRENCE CENA**  
President, Atchison, Topeka & Santa Fe Railway Co.

**JERRY G. CHAMBERS**  
Chairman of the Board, Clipper Express

**I.C. ETHINGTON**  
Executive Vice President, Burlington Northern, Inc.

**RALPH L. HENNEBACH**  
President, ASARCO, Inc.

**W. PATRICK BARRETT**  
Vice President — Traffic, Union Pacific Railroad Co.

**G. RUSSELL MOIR**  
Chairman of the Board, Transway International Corporation

**THOMAS M. BECKLEY**  
President, Soo Line Railroad Company

**L. BLACKKETTER**  
Vice President Purchasing, Inmont Corporation

**JAMES R. WOLFE**  
President and Chief Executive Officer,  
Chicago and Northwestern Transportation Company

**EDWARD J. McMAHON**  
Executive Vice President, St. Regis Paper Company

**W.E. ALEXANDER, JR.**  
Executive Vice President, Seaboard Coast Line Industries

**FRANK B. VARNER**  
Vice President Traffic and Transportation, United States Steel Corporation

**J.H. LLOYD**  
Vice Chairman, Missouri Pacific Railroad Co.

**FRANK L. MERWIN**  
Vice President, ASARCO, Inc.

**JOHN H. BURDAKIN**  
President, Grand Trunk Western Railroad Co.

## GUESTS — Continued

**JAMES M. GOFF**  
President, General American Transportation Corp.

**HAROLD L. GASTLER**  
President, Missouri-Kansas-Texas Railroad Co.

**JAMES OZANNE**  
President, North American Car Corporation

**ROBERT E. WYNKOOP**  
Vice President Sales, Southern Pacific Transportation Company

**KENNETH McLAUGHLIN**  
President, Universal Freight System

**ALAN G. DUSTIN**  
President and Chief Executive Officer, Boston and Maine Corporation

**TROY D. STUBBS**  
Vice President, National Piggyback Services, Inc.

**P.C. WHITE**  
Vice President — Marketing, Milwaukee Road

**PAUL J. TIERNEY**  
President, Transportation Association of America

**FRED C. BAUER**  
Executive Vice President Marketing, McLean Trucking Co.

**GEORGE H. ELLIS**  
First Vice President, Maine Central Railroad Co.

**THOMAS A. BROWN**  
Vice President Sales & Traffic, Time D.C. Inc.

**ANDREW J. CORBETT, SR.**  
President, A.J. Corbett & Sons

**DONALD F. HAGEN**  
Second Vice President, Traffic Club of New York, Inc.



## SEATING LIST Alphabetical

**COMPANY NAME**

**TABLE**

APA Transport Corporation.....	58
ASARCO Incorporated.....	25
American Commercial Barge Line Co.....	80-A
American Freight System.....	71-A
American Short Line Railroad Assoc.....	6-A
Amex Shipping Agent Inc.....	78
Arkansas Best Freight System.....	76
Bi-Model Corporation.....	2,3
Boston & Maine Corporation.....	15
Burlington Northern Inc.....	33, 36, 32, 37
C.B.S. Publications.....	80
CP Rail.....	63
C.W. Transport Inc.....	6-A
CN Rail.....	54
Chessie System.....	44, 50
Chicago and Northwestern Trans. Co.....	18
P. Chimento Co. Inc.....	75
Clipper Express.....	35
Commercial Lovelace Motor Freight Conrail.....	71-A 51, 52, 53, 59
Consolidated Freightways.....	11
Copper Development Association.....	80
Corbett, A.J. & Sons.....	6A
Crowley Maritime Co.....	72
Delaware & Hudson Railway Co.....	2
East Coast Shippers.....	56
East Jersey Railroad & Terminal Co.....	2
Eastern Railroad Association.....	6
Eaton Corporation.....	80-A
Evans Products - Rail Car Division.....	48
Family Lines System.....	41, 42, 43
Florida East Coast Ry. Co.....	71
Garrett Freight Lines.....	80
Gelco Rail Services.....	80-A
General American Trans. Co.....	47, 55-A, 55
Glove & Co. Inc.....	3
Green Bay & Western Railroad.....	3
Halls Motor Transit Co.....	80
Hapag-Lloyd.....	78
Robert G. Herd & Co. Inc.....	5
Illinois Central Gulf Railroad Co.....	73
IML Freight Inc.....	19
Interstate System.....	70
Kansas City Southern Lines.....	77
Lamotte Valley Railroad.....	57
Langer Transport Corporation.....	57
Langer Transport Corporation.....	10
Lee Way Motor Freight Co.....	65

## SEATING LIST Alphabetical

**COMPANY NAME**

**TABLE**

Linden Motor Freight Co. Inc.....	71-A
Lowaco International.....	71-A
Maislin Transport.....	46-A
Maryland Port Administration.....	78
Gerald L. McGrath.....	80
McLean Trucking Company.....	13, 14
Milwaukee Road.....	77
Missouri-Kansas-Texas Railroad Co.....	39, 46
Missouri Pacific Railroad Co.....	20
Naporano Iron & Metal Co.....	76
National Piggyback Services Inc.....	4
National Retail Transportation.....	80-A
Neptune World Wide Moving.....	76
Norfolk and Western Railway Co.....	49
No. American Car Corp.....	21, 22, 29, 29-A, 30
Oneda Motor Freight Inc.....	71-A
Pilot Freight Co.....	38-A
Pittsburgh National Bank.....	6-A
Port Authority New York and New Jersey.....	66
Port of New Orleans.....	80-A
Puerto Rico Marine Management.....	6-A
Public Service Traffic Bureau.....	80
Regional Import & Export Trucking Co.....	69
Riss International.....	61, 62
Santa Fe System.....	40, 45
Schieffelin & Co.....	76
Shippers Car Line.....	68
Soo Line Railroad.....	34
Southern Pacific Transportation Co.....	31, 38
Southern Railway Co.....	64
Spector-Red Ball Inc.....	16, 17
Technical Traffic Consultants Corp.....	80-A
TIME-D.C. Inc.....	9
Toledo Peoria & Western Railroad Co.....	12
Tollem Ocean Trailer Express.....	1
Trailer Train.....	79
Union Carbide Corporation - Carbon Products Div.....	26
Union Carbide Corporation.....	24, 27
Union Pacific Railroad Co.....	23, 28
Union Tank Car Co.....	7, 8
Universal Freight System.....	67
Virginia and Maryland Railroad.....	57
A.J. Weigand Inc.....	80
Western Carloading Co.....	1
Western Maryland Railway Co.....	60
Western Pacific Railroad Co.....	74
Whalen's Moving & Storage Co.....	1
Wiles, William A. (N&W R.R.).....	1



**CONSUMER PRODUCTS DISTRIBUTION, LTD.**  
23 ASH STREET  
BROOKLYN, NY 11222

There's a new dynamic force for pool distribution in the New York - New Jersey - Nassau - Suffolk - Westchester and the commercial free zone of Connecticut.

C.P.D. is ready to serve your distribution requirements to the above areas.

**POOL DISTRIBUTION - BREAK BULK**

Pool Distribution - Break Bulk  
Light Warehousing - Residential Deliveries  
Local Cartage - Truck Load

**Specialized Trucking Tailored To Your Needs.**

**MARIO NASTRO - PRESIDENT**

FOR ADDITIONAL INFORMATION CALL:  
**Jack Nastro**, Vice President, Sales 212-389-5400  
**Tony Ferone**, Vice President, Operations 212-389-5400



IML Congratulates the  
**Traffic Club of New York**  
for 75 Years of Service & Progress  
to Transportation.

Our Best Wishes to the  
New Officers  
for a Successful 1981!

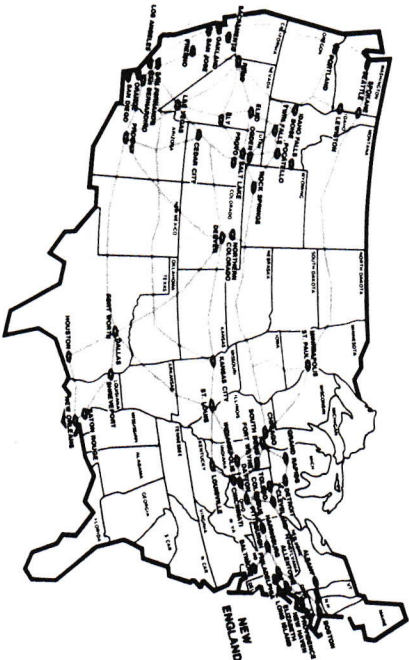

**IML FREIGHT, INC.**  
Salt Lake City, Utah

# Congratulations



Bill Rose

Marine Midland Corp.  
One Penn Plaza  
New York, NY 10119

\*\*\*\*\*  
**ANNOUNCING**  
\*\*\*\*\*

**I/A PUBLISHERS™**

TO ENGAGE IN THE PREPARATION,  
COMPILATION AND PUBLICATION  
OF INDIVIDUAL TARIFFS AND  
SCHEDULES OF ACTUAL RATES AND  
CHARGES FOR THE MOTOR CARRIER  
INDUSTRY.



For More Information Call  
(914) 835-4411 and ask for  
John L. Alfano

\*\*\*\*\*

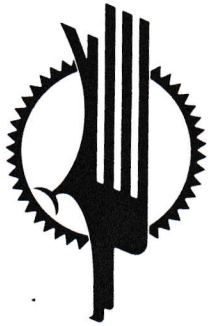

# MISSOURI PACIFIC RAILROAD

Salutes

## THE TRAFFIC CLUB OF NEW YORK

*Best Wishes for  
Continued Success*

Bill Rogers  
Harold Reavis  
Don Veidt



MISSOURI PACIFIC RAILROAD  
600 THIRD AVENUE  
NEW YORK, N. Y. 10016  
TELEPHONE: (212) 953-0960

# CANNY TRUCKING CO., INC.

ALL UNITS ARE RADIO EQUIPPED • DIRECT WIRE AND PHONE TO ALL TERMINALS

**Executive Offices**  
**PHONE: 607 724-1967**  
**8-18 SPRING FOREST AVENUE**  
**BINGHAMTON, NEW YORK 13905**

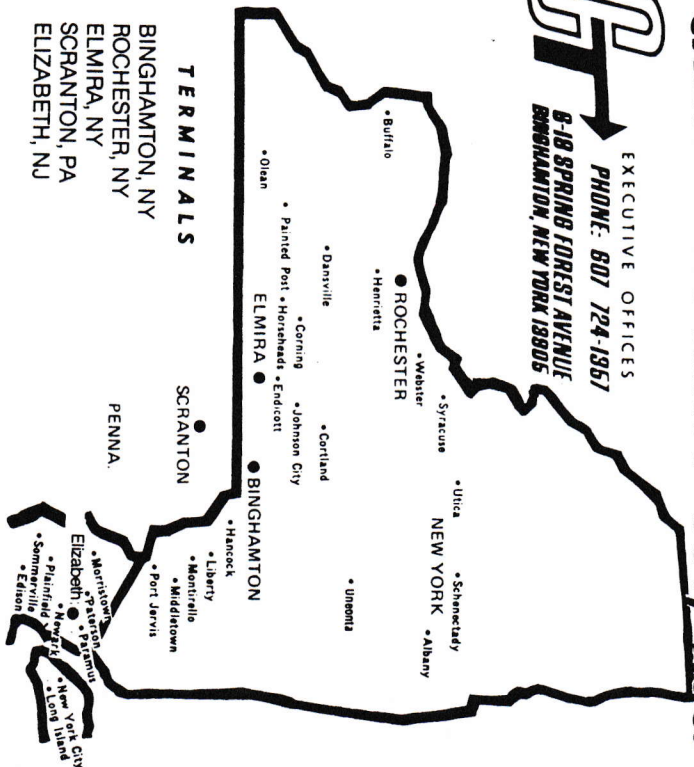

### TERMINALS

BINGHAMTON, NY  
ROCHESTER, NY  
ELMIRA, NY  
SCRANTON, PA  
ELIZABETH, NJ

FOR PROMPT PICKUP CALL:  
 FROM NEW JERSEY 201-355-1616  
 FROM NEW YORK 212-594-5855  
 TERMINAL LOCATED AT:  
 250 East North Avenue  
 Elizabeth, New Jersey

Please Contact Secaucus Terminal For Information on the following:  
 •IMPORT & EXPORT SERVICE AT ALL NY-NJ PIERS  
 •LOCAL DISTRIBUTION SERVICE  
 •WAREHOUSING •LOCAL N.J./NY FREIGHT SERVICE

PICKUP AGENT FOR CLIPPER EXPRESS FLORIDA, TEXAS, FRT.  
 CONTACT YOUR SALES REPRESENTATIVE FOR POINTS NOT LISTED HERE

*Call on Canny's — "Especially for you"*



## PUBLIC SERVICE TRAFFIC BUREAU, INC.

245 FIFTH AVENUE  
NEW YORK, NY 10016

(212) 532-4796  
est. 1901

•  
***With Best Wishes***

•  
ROBERT H. BLANK, President  
BRUNO LEPORATI, Vice President  
ROGER FAHEY, Manager Audit

## Nationwide network of Evans' Railcar Division facilities to back up our full service.

### Railcar Division Manufacturing Operations.

#### Six plants located at:

- Blue Island, Illinois
- Washington, Indiana
- Junction City, Kansas
- Atlanta and Chamblee, Georgia
- Ashland City, Tennessee

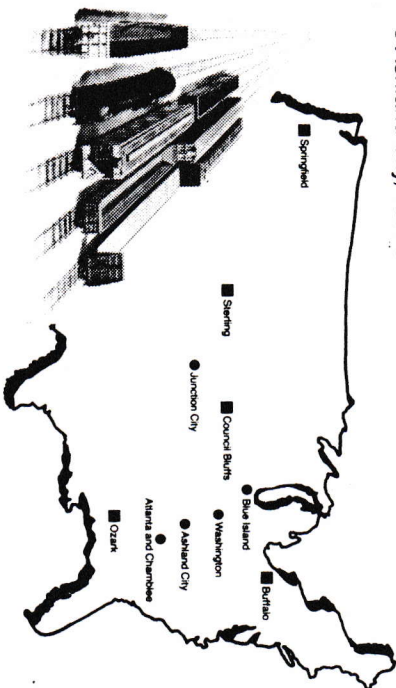

### Railcar Division Maintenance and Repair Operations.

#### Five plants located at:

- Buffalo, New York
- Council Bluffs, Iowa
- Springfield, Oregon
- Ozark, Alabama
- Sterling, Colorado



**EVANS RAILCAR DIVISION**

PRODUCTS COMPANY / TRANSPORTATION SYSTEMS & INDUSTRIAL GROUP  
East Tower • 2550 Golf Rd., Rolling Meadows, IL 60008 • Phone (312) 640-7000



AMERICAN SOCIETY OF TRAFFIC AND TRANSPORTATION, INC.  
Metropolitan New York Chapter

CONGRATULATIONS  
TO  
THE TRAFFIC CLUB OF NEW YORK  
ON ITS  
DIAMOND JUBILEE

Our purpose —  
"...to establish standards of knowledge, technical training, experience,  
conduct and ethics, requisite to the proper performance of the various  
functions of transportation...."

- |                           |                             |                            |
|---------------------------|-----------------------------|----------------------------|
| <b>PRESIDENT</b>          | <b>VICE PRESIDENT</b>       | <b>SECRETARY-TREASURER</b> |
| Herbert T. Landow         | Fred M. Zitto, Jr.          | Lanny Govic                |
| <b>BOARD OF GOVERNORS</b> |                             |                            |
| Robert O. Berardis        | Raymond Heinzelmann, Ph. D. | James C. Smith             |
| Marc S. Bernhardson       | Herbert T. Landow           | John R. Smith              |
| Eugene V. Fitzpatrick     | John C. Martin, Esq.        | Francis H. Watson          |
| Lanny Govic               |                             | Fred M. Zitto, Jr.         |

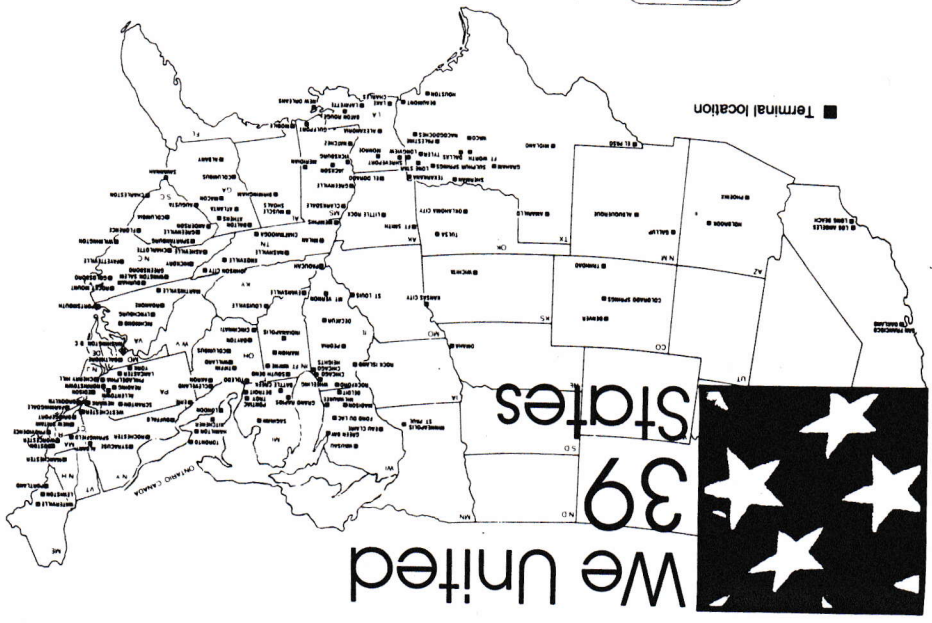

Home Office: SpectorRedBall Freight System, 3177 Irving Blvd., Dallas, TX 75247



**Nation's Number One  
HEAVY SPECIALIZED CARRIER**

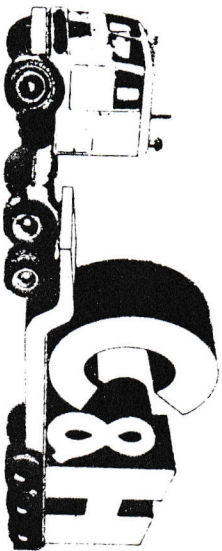

**C&H TRANSPORTATION COMPANY**

Subsidiary of Tyler Corporation  
9757 Military Parkway, P.O. Box 270535  
Dallas, Texas 75227  
Phone 288-3000



**BEST WISHES  
FOR A  
SUCCESSFUL NEW YEAR**

**HAPAG-LLOYD (AMERICA) INC.**



**QUADREL LEASING CORP.**

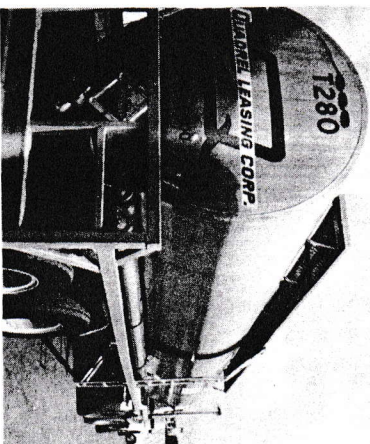

RAHWAY, NJ 07065  
1603 HART STREET  
(201) 381-6400

THE "FIRST" LEADING RO/RO TANK WAGON SERVICE  
TO AND FROM PUERTO RICO AND FOREIGN PORTS.

\* \* \*

**Compliments of**

**The Transportation and  
Distribution Department**

**St. Regis Paper Company**

\* \* \*



# DENEMHOLZ & JANER, INC.

234 FIFTH AVE., NEW YORK, NY 10001  
212-683-3044

## TRAFFIC & DISTRIBUTION CONSULTANTS

Rates ● Routes ● Audits  
Loss & Damage

## Congratulations

on the occasion of your

# 71st ANNUAL DINNER

from your friends at \_\_\_\_\_



**Saxon Industries, Inc.**  
*International Headquarters*  
1230 Avenue of the Americas  
New York, N.Y. 10020

## Asarco is basic to transportation.

Asarco's metals and minerals are essential to the nation's cars, trucks, buses, trains, ships and airplanes. Copper for wiring, radiators, condenser tubes and plates. Zinc for die-cast parts and trim, and to protect the steel in cars and ships against corrosion. Lead for batteries. Zinc oxide for tires. Asbestos for brake linings. ASARCO Incorporated, 120 Broadway, New York, N.Y. 10271.

# ASARCO

Metals & Minerals

## New Orleans. We wrote the book on service.

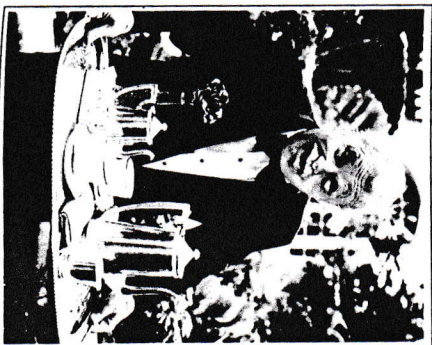

*Service (dictionary definition) the occupation or function of serving. Service (N.O. maritime community definition) — useful labor that produces tangible savings in time and money. Service (Port of New Orleans version) — experienced trade developers ready to serve where you are — Chicago, New York, St. Louis, Munich, Panama, Tokyo, Hong Kong, Melbourne, New Orleans. Try us for quick, accurate service.*

General Port of New Orleans, P.O. Box 60306, New Orleans, LA 70160 U.S.A. (504) 522-2511. TELEX 987466 CALB — CENTRO. PORT NEW YORK, Joseph E. Thomas, 617A, 42-0786, CHICAGO NEW ORLEANS, Will Landolt, 6000 522-2551.

### THE PORT OF NEW ORLEANS THE TOTAL PORT

CONGRATULATIONS TO THE  
TRAFFIC CLUB OF NEW YORK  
on their 75th Birthday



John A. Lane  
R.N. Cosentino

R.J. Everett  
Rita Russo

NATIONAL ELECTRONIC TRANSIT CORP.

"The Full Service Electronic Carrier"



- Complete Intrastate, Interstate, International and Air Service
- Comprehensive Warehousing Facilities
- Specially Equipped and Designed Vans
- Inside Pick-Up and Delivery
- Service You Can Depend On.



1250 VALLEY BROOK AVE.  
LYNDHURST, NEW JERSEY 07071  
(201) 939-6500

*Congratulations  
and Best Wishes to  
Bill Rose*

from one mover to another

*Barbara Oberlander  
Neptune World Wide Moving Inc.  
800-431-1158*

SERVICE MAP — UNIVERSAL FREIGHT SYSTEM

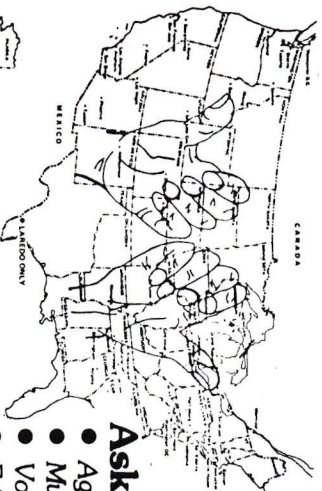

- Ask Us About Our:**
- Aggregate Rates
  - Multiple Pick-ups
  - Volume Rates
  - FAK Rates
  - Assembly
  - Distribution

*East or West Universal Freight System is the Best*



**Universal Freight System**  
Universal Cartloading & Dismantling Co.

345 Hudson Street  
New York, NY 10014  
(212) 741-7400

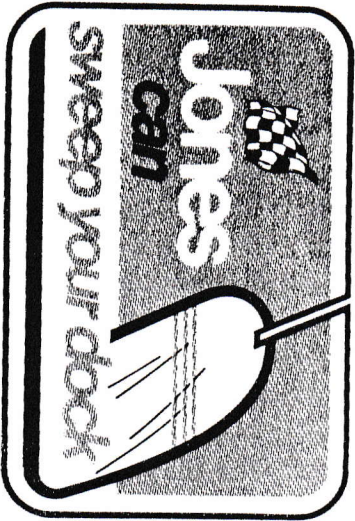

**Jones Motor**  
Bridge St. & Schuykill Road  
Spring City, Pennsylvania 19475  
Phone 215-948-7900

# PILLOT

**IN NEW YORK**  
call 212/391-3803

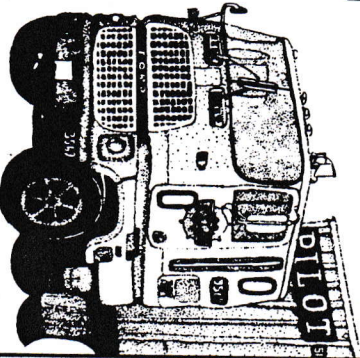

A Happy 75th Birthday

to the

Traffic Club of New York

From the family of Sun Carriers, Inc.

• • • • •

CARRIER SYSTEMS, INC. - Bayonne, NJ

(201) 823-4800

JONES TRUCK LINES, INC. - Springdale, AR

(501) 751-4806

MILNE TRUCK LINES, INC., - Salt Lake City, UT

(801) 972-6500

ST. JOHNSBURY TRUCKING CO., INC.

Holliston, MA (617) 429-5920

STANDARD TRUCKING CO., INC. - Charlotte, NC

(704) 332-1106



**LOOK AHEAD-LOOK SOUTH**

# 48 Years of Continuing Progress

**Rod Callahan**  
Eastern Mgr. National Accts.  
Bloomfield, NJ  
(201) 748-0024



**Joe Tramaine**  
Director of National Accts.  
Bridgeview, IL  
(312) 581-2000

**Jim Medworth**  
Southern Manager of National Accts.  
Greenville, SC  
(803) 288-1266

**THE CLOCK-WISE CARRIER Serving**  
Illinois - Indiana - Kentucky - Upper Michigan - Minnesota  
Missouri - Ohio - Wisconsin  
North Carolina - South Carolina - Atlanta, Georgia

CW Transport Inc. Wisconsin Rapids, Wisconsin 54494  
(715) 423-4500



**Illinois  
Central  
Gulf  
Railroad**

530 FIFTH AVE. NEW YORK, N.Y. 10036

212 560-3300

**YOU'VE  
GOT A LOT  
GOING FOR YOU  
AT ICG.**

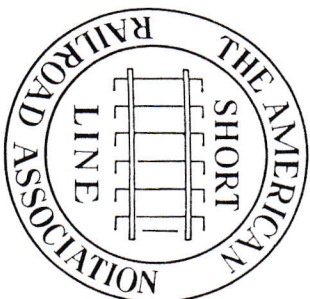

DOING COLLECTIVELY WHAT  
IS IMPOSSIBLE FOR THE  
INDIVIDUAL

*Going your way like never before*

"WITH BEST WISHES"



**MAESLIN**

Operators of Gateway Transportation Co. Inc. & Quinn Freight Lines, Inc.  
CORPORATE OFFICE 7401 Newman Blvd. Montreal Quebec H8N 1K4 (514) 354-7711  
(212) 736-0060 (201) 997-5400

For Personalized Service Call  
**SOL SELENFREUND**  
**SALES AND TRAFFIC**  
TRUCKING — WAREHOUSING — DISTRIBUTION  
PIGGYBACK — CONSOLIDATION  
(All across the Nation)

P.O. BOX 311 N.Y.C.  
FAIRLAWN, NJ 07410 212-354-7800

BEST WISHES FROM  
LINDEN MOTOR FREIGHT CO., INC.



LINDEN WAREHOUSE & DISTRIBUTION CO., INC.

# **daily** express. inc.

HEAVY & SPECIALIZED HAULING  
P. O. BOX 39 / CARLISLE, PA 17013 / 717-243-5757

Phone (201) 736-3804

**MEL LOESER ASSOCIATES, INC.**  
specialist in irregular and contract carriage

21 Devon Drive  
West Orange, NJ 07052

**BEST WISHES FOR A SUCCESSFUL YEAR**



**TECHNICAL TRAFFIC CONSULTANTS CORP.**  
Freight Auditing Services

20 Squadron Boulevard  
New City, New York 10956  
914-638-1050

*The Milwaukee Road  
Tells Your Transportation Needs*

*George Sawner  
1-800-621-0766*

CONGRATULATIONS - TRAFFIC CLUB OF NEW YORK  
ON THE OCCASION OF YOUR 71st ANNUAL DINNER



**Western Pacific  
Railroad Company**  
"THE FEATHER RIVER ROUTE"

For information and assistance contact:  
Don Schroen / Bill Gurgurich / Harvey Ezekiel  
Phone: (203) 356-1620

**AMERICAN RED BALL TRANSIT CO.**  
Eastern Division

**WISHES YOU A HAPPY BIRTHDAY**

**Tom Parker, Vice President**

ARTIM TRANSPORTATION SYSTEM, INC.



**General Office Center**  
8400 Westlake Drive  
P.O. Box 8414  
Merrillville, IN 46410

Call - (219) 738-4500  
(800) 348-9201

**Best Wishes**

**Consolidated Freightways**



GOOD LUCK IN 1981

From All of Us at

MISSOURI-KANSAS-TEXAS RAILROAD CO.

195 Main St., Metuchen, NJ 08840

212-986-0750

201-549-3210

*Congratulations on the  
75th Year of the  
Traffic Club of New York*  
*Ben Giaretta*

**FLORIDA EAST COAST RAILWAY COMPANY**

OFFERS

SEVEN PIGGYBACK SCHEDULES DAILY BETWEEN  
JACKSONVILLE AND SOUTH FLORIDA POINTS

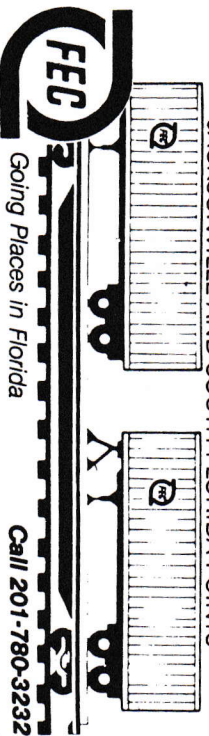

Call 201-780-3232



"Concentrating On Mid America"

**HAPPY BIRTHDAY  
TRAFFIC CLUB OF NEW YORK**

- |                          |                                      |
|--------------------------|--------------------------------------|
| M. S. Bernhardtson,      | Soo Line Railroad                    |
| R. E. Murphy,            | Chessie System                       |
| E. L. Erickson,          | Union Pacific Railroad Co.           |
| J. A. Callaway,          | Union Pacific Railroad Co.           |
| J. T. Meany,             | Union Pacific Railroad Co.           |
| J. P. Monks,             | Norfolk & Western Railway Co.        |
| M. Rondholz,             | Burlington Northern Inc.             |
| E. D. Onieal,            | Burlington Northern Inc.             |
| Nat Cohen,               | Price & Pierce International<br>Esq. |
| I. T. Bergman, Esq.      | Southern Pacific Trans. Co.          |
| T. P. Gallaway,          | Corbett International                |
| F. L. Kunz,              | Chessie System                       |
| G. T. Barker,            | Family Lines System                  |
| E. T. Tucker,            | Searock Trading Corp.                |
| F. T. Sherman,           | Family Lines Systems                 |
| T. A. Downes, Jr.,       | Union Carbide Corp.                  |
| L. L. Dintiman,          | (Retired)                            |
| A. C. Schier             | ITOFCA Inc.                          |
| L. Feldman,              | Linden Motor Freight                 |
| S. H. Salz,              | (Retired)                            |
| J. L. Evans              | (Retired)                            |
| V. G. Berdolt            | (Retired)                            |
| J. P. Brady              | (Retired)                            |
| J. W. Hubbard            | (Retired)                            |
| J. Kaye, Quality Service | Quality Service Associates           |
| R. F. Kist,              | Perkins Goodwin Co.                  |
| George Young             | (Retired)                            |
| J. W. Peterson           | (Retired)                            |
| Mel Loeser,              | Mel Loeser Associates                |
| K. J. Burrows,           | Regional Import & Export Trucking    |
| M. J. Walsh, Jr.,        | St. Regis Paper Co.                  |
| S. L. Hamilton,          | Port of Oswego Authority             |
| G. E. Delano, Jr.        | (Retired)                            |
| I. M. Schofield,         | Nelson Freightways                   |
| C. G. Moberg,            | Westinghouse Electric Corp.          |
| J. E. Fioramo,           | Port of New Orleans                  |
| L. E. Smith,             | Pulp Transport Ltd.                  |
| R. R. Lindley,           | Spector Industries                   |
| W. J. Landrie,           | National Moving & Warehouse Corp.    |
| Seton Ijams,             | National Distillers                  |
| E. J. McCarthy,          | American Can Co.                     |

**HAPPY BIRTHDAY  
TRAFFIC CLUB OF NEW YORK**

W. H. Magrath,  
R. A. Pepper,  
C. E. Feuerstein,  
J. W. Markert,  
J. H. Brautman,  
E. W. Johnson,  
J. W. Pidgeon,  
S. W. Hoback,  
N. R. Cosentino,  
E. R. Herlthy,  
H. W. Swank,  
T. K. Turner,  
C. E. Kessler,  
W. R. Wilfong,  
T. J. O'Neill,  
G. W. Cunningham,  
J. F. McNally,  
Ronald Kennedy  
J. B. Scott  
Armond Heerman,  
J. Lawrence,  
R. R. Morin,  
V. J. Landi,  
J. A. Punola,  
R. B. Cook,  
W. J. Jeffs,  
F. Donovin,  
J. A. Lane,  
K. W. Kirchner,  
P. A. Berman,  
T. L. Parrey,  
C. J. Bagnall,  
Leo Piovano,  
J. F. Roesser, Jr.,  
F. J. Fills,  
W. J. Arnold,  
Edward Keil  
T. P. Connelly,  
T. J. Scholtz,  
W. W. Weil,  
J. H. Brautman,  
Ingersoll Rand Co.  
Toledo Peoria & Western Railroad Co.  
All State Vehicles Inc.  
Union Pacific Railroad Co.  
Western Carloading Co.  
Pheps Dodge Corp.  
Lea & Perrins Inc.  
Burlington Northern Inc.  
Consolidated Rail Corp.  
Pilot Freight Carriers Inc.  
A.C.F. Industries, Shippers Car Line Div.  
Transit Services Inc.  
American Chain of Warehouses  
Bair Transportation - Columbia Div.  
Diamond International  
Florida East Coast Ry. Co.  
Bulkeley Dunton & Co.  
(Retired)  
(Retired)  
Great Lakes Carbon Co.  
Art Staff Inc.  
CP Rail  
Great Lakes Carbon Co.  
Missouri, Kansas & Texas Railroad Co.  
Erskine Freight Forwarding Co. Inc.  
Westranco Freight Co.  
Gordons Transports Inc.  
Kansas City Southern Railway Co.  
Green Bay & Western Railroad Co.  
BP Chemicals Americas Inc.  
Western Pacific Railroad Co.  
Maersk Line Agency  
Universal Transcontinental Corp.  
American Can Co.  
Omnium Agencies  
A. J. Weigand Inc.  
(Retired)  
East Jersey Railroad & Terminal  
Norfolk & Western Ry. Co.  
Meridian & Bigbee Railroad Co.  
Western Carloading Co.

**HAPPY BIRTHDAY  
TRAFFIC CLUB OF NEW YORK**

R.N. Buchheit,  
K.J. Lombardo,  
J.E. McNamara,  
R.M. Ortega,  
W.P. Cosentino,  
J.H. O'Brien,  
Loula Miller,  
J.J. Collins,  
E.H. Stann,  
W.J. Arnold,  
E.G. Leoffler,  
A.G. Milligan  
William Burghardt,  
A.H. Grevers,  
E. Johnson,  
S.S. Eisen,  
Paul H. Schoepflin,  
J.L. Sonntag,  
R.J. Everett,  
F.E. Deines,  
Wilfred Greenway,  
Barbara Oberlander,  
E.F. Hogan,  
B.J. Fischer,  
Leo Frechette  
E.F. Bolten,  
Miner Enterprises Inc.  
M.J. Bernel, Jr.  
L.J. Welter,  
D.A. Dufault,  
G.A. Sansverie,  
Alan Hudson  
J. Langhorne Tompkins,  
Sister Sheila Monks,  
Florence C. Bunyea  
Franz D'Zurilla,  
Robert G. Clark,  
C.P. Russo,  
Anne Comerford,  
James C. Gustus,  
Norman Rovine,  
A.C. Fennimore,  
John McCaffrey,  
William B. Rose, Jr.,  
D.J. Quinn,  
Chessie System  
Freeport Kaolin  
Burlington Northern Inc.  
Burlington Northern Inc.  
Burlington Northern Inc.  
Burlington Northern Inc.  
Burlington Northern Inc.  
Dravo Mechling  
Metallurg Inc.  
A.J. Weigand Inc.  
Burlington Northern Inc.  
(Retired)  
Brown and Bryan Lumber Co.  
New York Navigation Co.  
Price & Pierce International Inc.  
Eisen & Mitchell  
Niagara Blower Co.  
United States Lines  
Kansas City Southern Ry. Co.  
Burlington Northern Inc. (Retired)  
Common Sense Systems Inc.  
Neptune World Wide Moving  
Preston Trucking Co.  
Trinity Industries  
(Retired)  
BASF Wyandotte  
A Friend  
Nationwide Transportation Products  
Hapag-Lloyd (America) Inc.  
Continental Grain Company  
Milwaukee Road  
(Retired)  
Potash Co. of America  
Arnold, MO  
Wife of George  
Foster Wheeler Energy Corp.  
Union Carbide Corporation  
Traffic Club of New York, Inc.  
Traffic Club of New York, Inc.  
Bay Shore Moving & Storage Inc.  
National Retail Transportation  
American Cyanamid Co.  
Pheps Dodge Corporation  
Western Carloading Co.  
Spector-Red Ball, Inc.

**HAPPY BIRTHDAY  
TRAFFIC CLUB OF NEW YORK**

Raymond Schifferdecker	(Retired)
Antoine Kenyan	(Retired)
V. R. Simmons,	Smith's Transfer Corp.
W. J. Gonda,	Interstate Systems
R. H. Lochhead,	Ecuadorian Line
J. J. McBride	
J. A. Angolia,	Corning Glass Works
B. N. Leporati,	Public Service Traffic Bureau
E. J. Fitzgerald,	CP Rail
A. J. Turco,	Universal Freight Systems
J. S. Zigo,	Moore McCormack Lines
J. R. Morton,	Combustion Engineering
Kenneth McLaughlin,	Universal Freight Systems
F. T. Robertie,	Maersk Lines
C. H. Ficken	(Retired)
J. M. Zachara	(Retired)
G. L. McGrath	(Retired)
C. J. Lancaric,	Maryland Port Administration
Gerald Nusbaum,	Brown Transport
J. R. Allen,	Canadian National Rys.
H. J. Madden,	Clipper Express
J. F. Nellis,	Clipper Express
D. F. Hagen,	Soo Line Railroad
P. F. Egeler	(Retired)
Mr. & Mrs. E. V. Fitzpatrick,	Family Lines System
Mr. & Mrs. James J. Fitzpatrick	
E. Sean Fitzpatrick	
Kelly Fitzpatrick	
Mary Fitzpatrick	
Meg Fitzpatrick	
Patricia Fitzpatrick	
Robert Kern	
H. G. Thone,	ANR Freight System
T. P. Hart,	Halls Motor Transit Co.
J. L. Lariviere,	Mercury Motor Express
J. T. Walker,	Burlington Northern Inc.
F. C. Forward,	Burlington Northern Inc.
J. E. Lappin,	Chessie System
G. W. Bunyaea,	Chessie System
R. A. Jordan,	Boston & Maine Corporation
Herbert Wilson, Jr.,	Chessie System

**HAPPY BIRTHDAY  
TRAFFIC CLUB OF NEW YORK**

O. S. de Menna,	Norfolk & Western Railway Co.
F. A. Livoti,	Interstate Express Inc.
J. M. McCloud,	Norfolk & Western Ry. Co.
R. K. Clarahan,	Norfolk & Western Ry. Co.
G. Mancini,	Hansen & Tidemann Inc.
C. E. Predmore,	Norfolk & Western Ry. Co.
R. B. Hitchcock,	Duff Truck Line
F. C. Reisse	(Retired)
H. H. Huston	(Retired)
W. J. Honan, Sr.	(Retired)
Norman Rovine,	National Retail Transportation
A. D. Redmond,	Western Maryland Ry. Co.
E. E. Nickel,	Rapid Transport
C. F. Clark,	Jepsen M & S
G. A. Schilling,	Vallerie Trans. Service
R. A. Small,	Phelps Dodge Corp.
T. H. Wrobel,	International Commodities Export
W. T. Hoffmann,	Richmond/Fredericksburg & Potomac R.R. Co.
Herb Mazzini,	Sun Carriers Inc.
M. J. Riordan,	Soo Line Railroad
F. Provan,	Provan Transport Corp.
W. C. Ort	(Retired)
J. M. Connelly,	Western Carloading Co.
T. F. Parker,	American Red Ball Transit
G. J. Robinson	Eastern Railroads Assn.
J. C. Regan,	Intercontinental Cellulose
J. A. Helm,	St. Regis Paper Co.
J. A. Kunke,	Tri State Motor Transit
D. P. Collins, Jr.,	Family Lines System
J. R. Eaton,	T.C.I.
J. L. Loftus	(Retired)
S. Glanzberg,	Cargo Distribution Inc.
R. C. Bell,	Allied Chemical Co.
W. F. Pick,	Southern Pacific Trans. Co.
Daniel Epstein,	C.B.S. Publications
G. W. Armstrong,	Chicago & North Western Trans. Co.
A. J. Corbett, Jr.,	A. J. Corbett & Sons
D. C. Kikeary,	McNally International
D. L. Skinner,	Santa Fe Railways System
J. J. Malone,	J. J. Malone Agency
John J. Bailey,	Chessie System
Frank Skinner,	Chessie System





Appreciate  
your  
traffic manager  
(ABF does)

Coast-to-  
Coast and  
Border-to-  
Border....

WE'VE GOT A LOT  
MORE GOING FOR  
YOU.... THAN  
EVER BEFORE!



106 terminals  
serving  
35 states  
direct...

ABF FREIGHT SYSTEM, INC.

CONGRATULATIONS  
TO GENE

AND GENE

FROM **phelps**  
*dodge*  
Corporation

TRAFFIC

DEPARTMENT

AND EUGENE

CONGRATULATIONS and HAPPY BIRTHDAY



Employees • of the Traffic Club of New York

We, THE TRAFFIC CLUB OF NEW YORK, gratefully acknowledge and thank the following firms for their participation in this program:

- ACF Industries
- APA Transport
- ASARCO Incorporated
- Altano and Altano
- American Can Company
- American Red Ball
- American Short Line R.R. Assn.
- American Society of Traffic and Transportation
- Arkansas Best Freight Systems
- Artin Transportation System
- Boston and Maine Corporation
- Burlington Northern Inc.
- C & H Transportation Company
- C & W Transport, Inc.
- CP Rail
- Canadian National - Grand Trunk Railways
- Canny Trucking Company
- Chicago & Northwestern Transportation Co.
- Clipper Express
- Consolidated Freightways
- Consumer Products Distribution
- CSX - Family Lines - Chessie System
- Daily Express
- Denenholz & Janer
- Eastern Traffic Council
- Emery Air Freight
- Evans Railcar Division
- Florida East Coast Railroad
- Ben Glaretta
- Gordon's Transport
- Hall's Motor Transit Company
- Hapag-Lloyd (America) AG
- IML Freight
- Illinois Central Gulf Railroad
- Ingersoll-Rand
- Inmont Corporation
- International Food Transport
- Jones Motor
- Kansas City Southern

**We, THE TRAFFIC CLUB OF NEW YORK, gratefully acknowledge and thank the following firms for their participation in this program:**

Lamolle Valley Railroad  
Linden Motor Freight  
Maersk Line - Moller Steamship Company, Inc.  
Malslin (Gateway Transportation Co. & Quinn Freight Lines)  
Mel Loeser Associates  
McLean Trucking Company  
Midland Marine Corporation  
The Milwaukee Railroad  
Missouri-Kansas-Texas Railroad  
National Electronic Transit Corporation  
Neptune World Wide Moving  
Norfolk & Western Railway Company  
Phelps Dodge Corporation  
Pilot Freight Carriers  
Port of New Orleans  
Public Service Traffic Bureau  
Puerto Rico Marine Management Inc. (Navieras)  
Quadrel Leasing  
Regional Import & Export Trucking  
Riss International  
St. Regis Paper Co.  
Santa Fe Railroad  
Saxon Industries  
S. Seelentfreund Sales and Traffic  
Soo Line Railroad  
Southern Pacific Transportation  
Southern Railway System  
Spector - Red Ball  
Sun Carriers  
Technical Transport Consultants  
The Traffic Club of New York Employees  
Union Carbide Corporation  
Union Pacific Railroad Company  
Union Tank Car Company  
Universal Freight System  
Western Carloading Company  
Western Pacific Railroad  
Witco Chemical

# Best Wishes

to  
**BILL ROSE**  
from  
Arthur and George

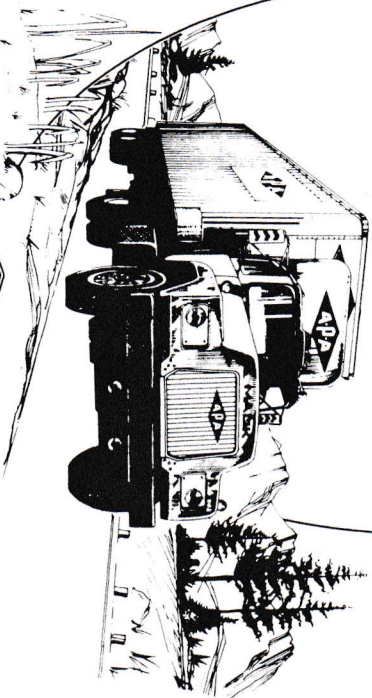

**A-P-A TRANSPORT CORP.**  
**A-P-A TRUCK LEASING CORP.**  
Executive Offices, North Bergen, New Jersey 07047



